

Himalaya
ABADI
the glassavvy

PRODUCT
CATALOGUE

GLASS & FILM

OUR DISTRIBUTION NETWORK :

glassmart 

glassmart *Express*



Himalaya
ABADI
the glassavvy

Himalaya Abadi is the answer for both inspirational and innovative needs in Indonesian Architectural and interior Glass Industry.



Shades of
LUMINOUS
| BIRD GREY

THE
FINUA
|

finua |

On Clear Plast Glass
RAL 3016

On Clear Plast Glass
RAL 3014

On Clear Plast Glass
RAL 3011

GREY ACID
MIRROBASE 192

finua |

finua |

WHITE PAPER

MIRROBASE |

MIRROBASE |

CONTENT



4



28

GUARDIAN
ULTRAMIRROR™

10



30



12



32



18



34



20



38



22



40



24

U-Shaped Glass

42



GLASSTONE STANDARD

TYPE : SUPER WHITE - 5MM

Glass Product



GlassTone is a product of glass material with painted on the back side using special glass paint, then coated with protective paint (double coated). The coated also hides the unnecessary view of adhesive material from the front (such as glue and other) used during installation. Now GlassTone also has a single coating variant, therefore you can choose according as you need.

This product has a solid color, strong, and durable. The touch of color on the glass provides an attractive appearance while improving the quality of furniture products or the design of the room.

Available with 8 standard color variants, it ready to use without having to wait for the manufacturing process.

GLASSTONE STANDARD SPECIFICATION

TYPE	THICKNESS	MAX SIZE
1. White/ Mono White	5 mm	2134 x 3048 mm
White	8 mm	2134 x 3048 mm
2. Super White/ Mono Super White	5 mm	2134 x 3300 mm
Super White	8 mm	2140 x 3660 mm
3. Black/ Mono Black	5 mm	2134 x 3048 mm
4. Light Grey	5 mm	2134 x 3048 mm
5. Blue	5 mm	2134 x 3048 mm
6. Red	5 mm	2134 x 3302 mm
7. Orange	5 mm	2134 x 3048 mm
8. Yellow	5 mm	2134 x 3048 mm



GLASSTONE MATTE

TYPE : MATTE BRONZE - 5MM



Glass Product

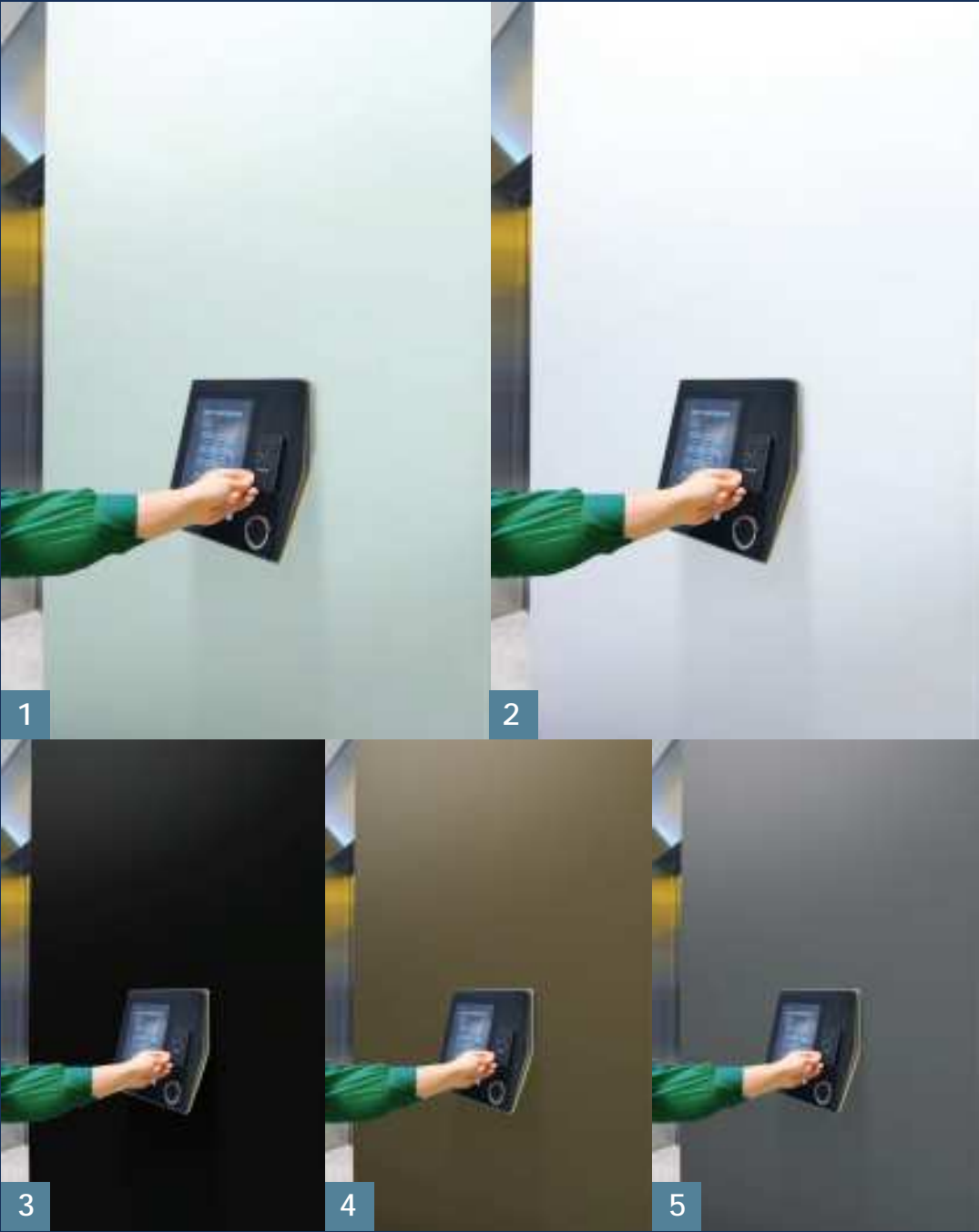

GlassTone now complements the standard type with matte effect. This Product is called the GlassTone Matte Series. Therefore to those who would like and prefer matte finish for their back painted glass, it is possible with these variation for GlassTone Matte Series.

The matte finish GlassTone Matte is done by applying the same solid color coating with an acid etched glass, this will create a phenomenal and luxurious effect for interior design element. The standard GlassTone Matte Series is produced with 5 types of colors that you can choose from in order to match the design theme of your interior.

GLASSTONE STANDARD SPECIFICATION

TYPE	THICKNESS	MAX SIZE
1. Matte White	5 mm	2080 x 3250 mm
2. Matte Super White	5 mm	2080 x 3610 mm
3. Matte Black	5 mm	2080 x 3250 mm
4. Matte Bronze	5 mm	2080 x 3610 mm
5. Matte Grey	5 mm	2080 x 3610 mm

GLASSTONE CUSTOM

TYPE : RAL 4004 ON FLOAT GLASS 5MM



Glass Product



GlassTone Custom provides more color choices. It will be customized according to the RAL Color guide book or color card. You can check further information about RAL Color by contacting our staffs.

Not only can be color customized, now GlassTone Custom allows to be produced on many glass substrate. Therefore it will have 2 options for the effects. Gloss Effect if to be produced on a Crystal Clear Glass substrate and Clear Float Glass, or a Matte Effect if it is produced on an Acid Etched Glass substrate.

Lastly, now it can also be toughened through a tempering process. Thus making the application of GlassTone Custom more versatile for areas.

GLASSTONE CUSTOM SPECIFICATION

TYPE	THICKNESS	MAX SIZE
GlassTone RAL Color on Clear Float Glass	5 mm	2134 x 3048 mm
GlassTone RAL Color on Clear Float Glass	6 mm, 8 mm, 10 mm, 12 mm	2134 x 3048 mm
GlassTone RAL Color on Crystal Clear Glass	5 mm	2140 x 3300 mm
	6 mm, 8 mm, 10 mm, 12 mm	2140 x 3660 mm
GlassTone RAL Color (Matte) on Acid Etched Glass	5 mm	2080 x 3250 mm
	10 mm	2080 x 3610 mm
GlassTone RAL Color (Matte) on Super Clear Acid Etched Glass	5 mm	2080 x 3610 mm



GUARDIAN ULTRAMIRROR

TYPE : SUPER CLEAR - 5MM

Glass Product

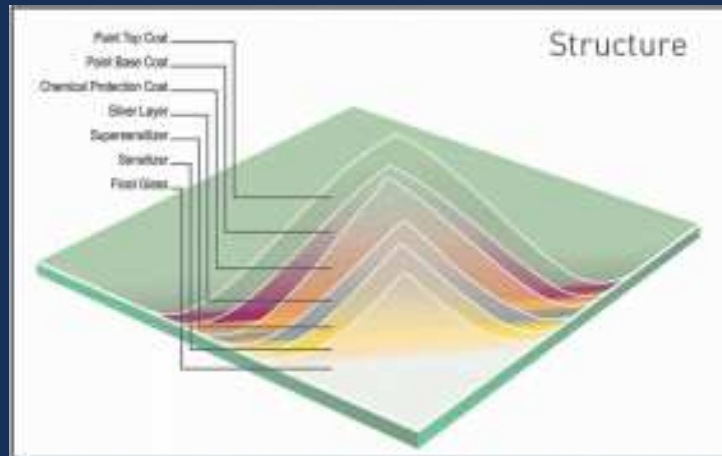

Guardian UltraMirror™ most beautifully reflective and durable product, providing unparalleled protection against corrosion, chemicals, moisture and abrasion while adding beauty and elegance to any setting.

When purchasing a Guardian UltraMirror™, you are buying years of experience. Guardian UltraMirror™ brings new dimensions into play. Small and confined spaces become bigger. Dark and dull rooms become filled with light.

Guardian UltraMirror™ is highly reflective and offers a true image reflectance with virtually no distortion. It is durable and long last. And more protected than conventional mirror, up to three times according to ISO 3770.

Guardian UltraMirror™ respects the environment with copper free mirror. It can be used in environments up to 60°C and can be used in environments where moisture is present but cannot be immersed in water.

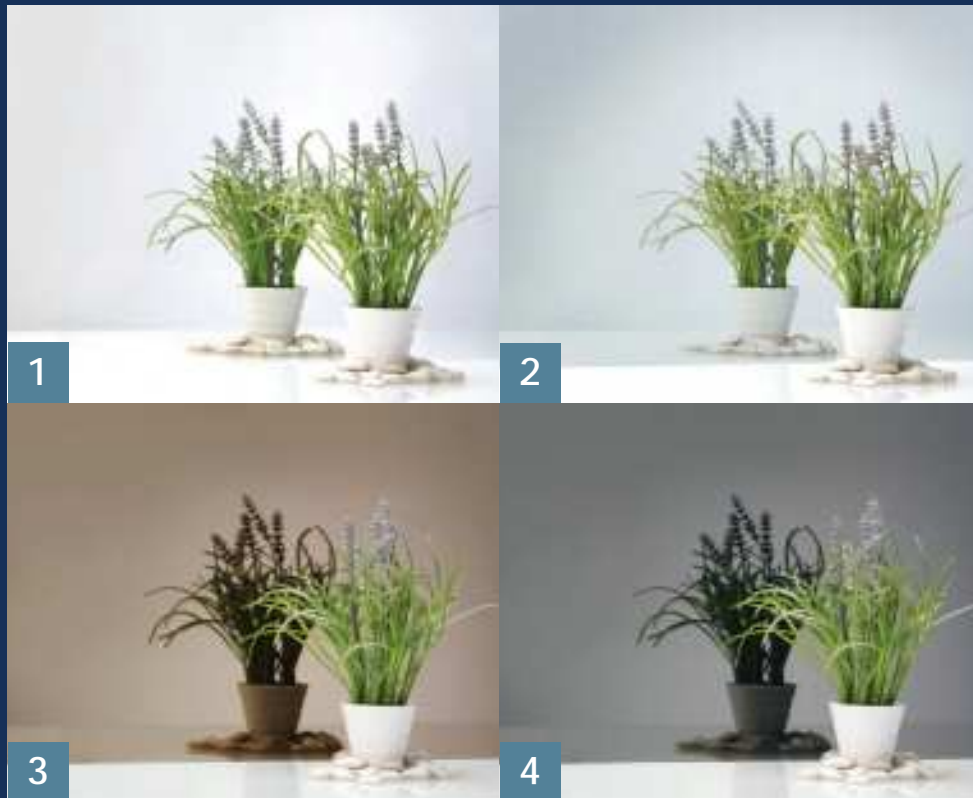

ULTRAMIRROR™ SPECIFICATION

TYPE	THICKNESS	MAX SIZE
1. UltraMirror™ - Super Clear	5 mm	2134 x 3048 mm
2. UltraMirror™ - Clear	5 mm	2134 x 3300 mm
UltraMirror™ - Clear (Big Size)	5 mm	2438 x 3658 mm
3. UltraMirror™ - Euro Bronze	5 mm	2134 x 3050 mm
4. UltraMirror™ - Euro Grey	5 mm	2140 x 3050 mm

MIRROMAX COLOR

TYPE : TITANIUM - 5MM



* Oxidized Ordinary Mirror

Glass Product

Mirromax Color is a leadless decorative mirror product, which has a colored coating from titanium and various kind of metals, which is given to Clear Float Glass or Tinted Float Glass. The coating layer with stainless steel and titanium material will provide everlasting usability in the luxurious appearance of an interior or exterior.



MIRROMAX COLOR SPECIFICATION

TYPE	THICKNESS	MAX SIZE
1. Bronze	5 mm	1830 x 2440 mm
2. Gold	5 mm	1830 x 2440 mm
3. Yellow	5 mm	1830 x 2440 mm
4. Blue	5 mm	1830 x 2440 mm
5. Green	5 mm	1830 x 2440 mm
6. Grey	5 mm	1830 x 2440 mm
7. Orange	5 mm	1830 x 2440 mm
8. Red	5 mm	1830 x 2440 mm
9. Purple	5 mm	1830 x 2440 mm
10. Titanium / Titanium +	5 mm	1830 x 3050 mm
11. Champagne	5 mm	1830 x 2440 mm
12. Rose Gold	5 mm	1830 x 2440 mm



MIRROMAX ARTE

TYPE : WHISKY - 5MM

Glass Product



Mirromax Arte is a mirror product with a variety of decorative patterns, with an antique look and special patterns as if rusty.

Mirromax Arte is produced by combining chemical process on the glass material to create a rusty effect while not damaging the coating, therefore the rust effect will not spread like a conventional antique mirror.

Therefore, Mirromax Arte gives a new unique sensation through a mirror product with imperfect reflection effects.

MIRROMAX ARTE SPECIFICATION

TYPE	THICKNESS	MAX SIZE
1. Amethyst	5 mm	1830 x 2440 mm
2. Riff	5 mm	1830 x 2440 mm
3. Brunn	5 mm	1830 x 2440 mm
4. Zitroen	5 mm	1830 x 2440 mm
5. Jasper	5 mm	1830 x 2440 mm
6. Whisky	5 mm	1830 x 2440 mm



MIRROMAX PATTERN

TYPE : INTERSECTION - 5MM+5MM (LAMINATED)

Glass Product

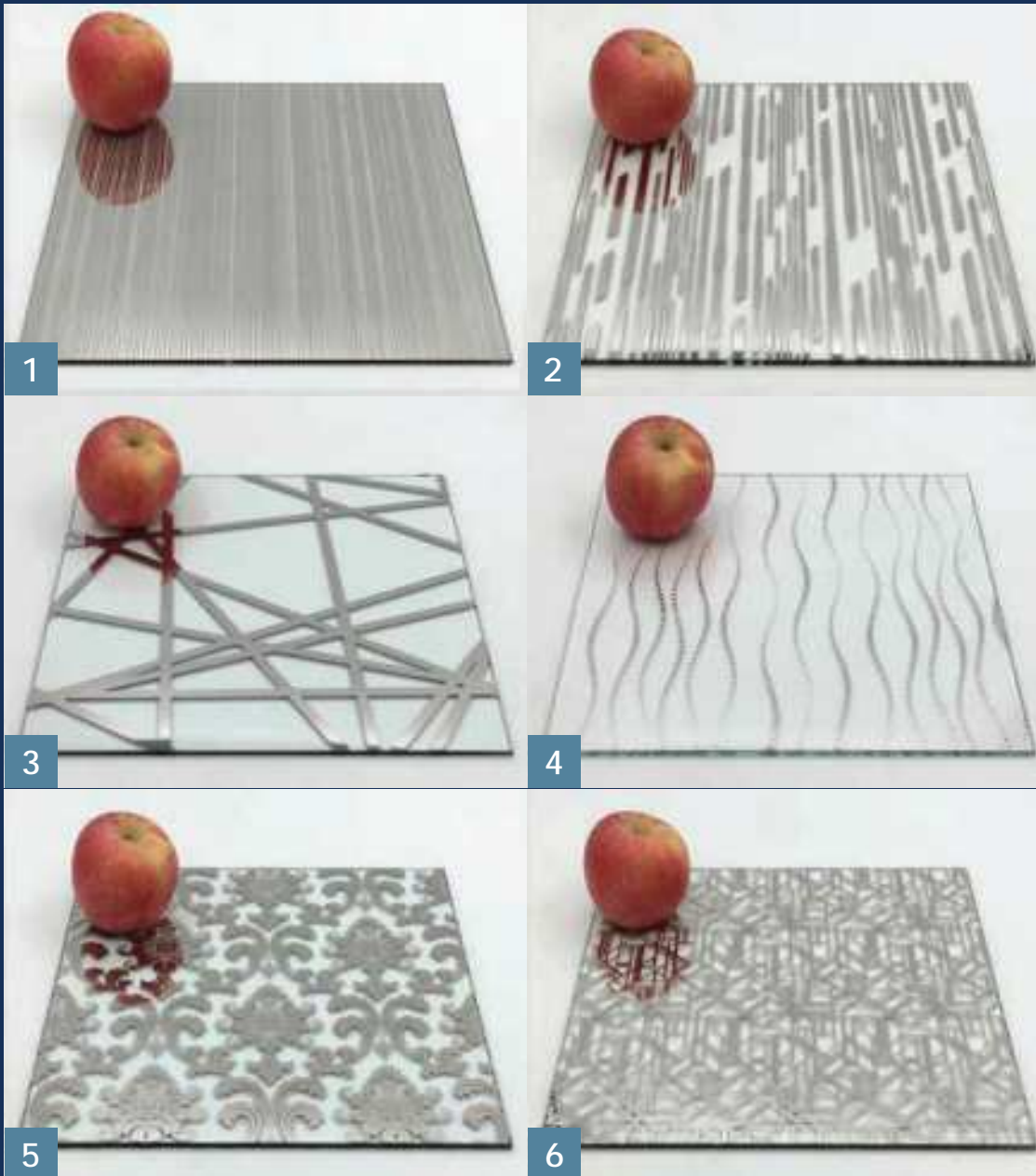

Mirromax Pattern is a mirror product which has a reflective pattern on the coating side.

The reflective pattern is a permanent because the coating are made of titanium based composition.

This mirror is perfect for the application that requires a reflective pattern on a transparent glass, thus enhances the aesthetics of the design.

MIRROMAX PATTERN SPECIFICATION

TYPE	THICKNESS	MAX SIZE
1. Filament	5 mm	1830 x 3050 mm
2. Cascade	5 mm	1830 x 3050 mm
3. Traverse	5 mm	1830 x 3050 mm
4. Convolution	5 mm	1830 x 3050 mm
5. Diadem	5 mm	1830 x 3050 mm
6. Intersection	5 mm	1830 x 3050 mm



WALL FILM GLASS

TYPE : GOLD HAIRLINE - 5MM

Film Product



WallFilm is a new decorative glass PET film with attractive colors and patterns that can be used as a glass panel to cover the walls. It has a special material structure, it will give the impression of elegance, and meanwhile also very safe if broken. If the glass shattered it will be retained by WallFilm. This film material can be combined with clear glass or tinted glass.

WALLFILM SPECIFICATION

TYPE	THICKNESS	MAX SIZE
1. Silver Hairline	5 mm	1200 x 3000mm
2. Gold Hairline	5 mm	1200 x 3000mm
3. Amber Hairline	5 mm	1200 x 3000mm
4. Red Hairline	5 mm	1200 x 3000mm
5. Rose Hairline	5 mm	1200 x 3000mm
6. Yellow Hairline	5 mm	1200 x 3000mm
7. Smoke Green Hairline	5 mm	1200 x 3000mm
8. Smoke Blue Hairline	5 mm	1200 x 3000mm
9. Blue Hairline	5 mm	1200 x 3000mm



FINURA

TYPE : SILVER CUBE - 5MM

Film Product

Finura is an innovative decorative glass that combines PET film and textured glass, therefore it creates a unique pattern feature. Finura – filmed glass can be used as a decorative glass panels to enhance the luxurious and modern interior atmosphere because of its decorative nature.

FINURA SPECIFICATION

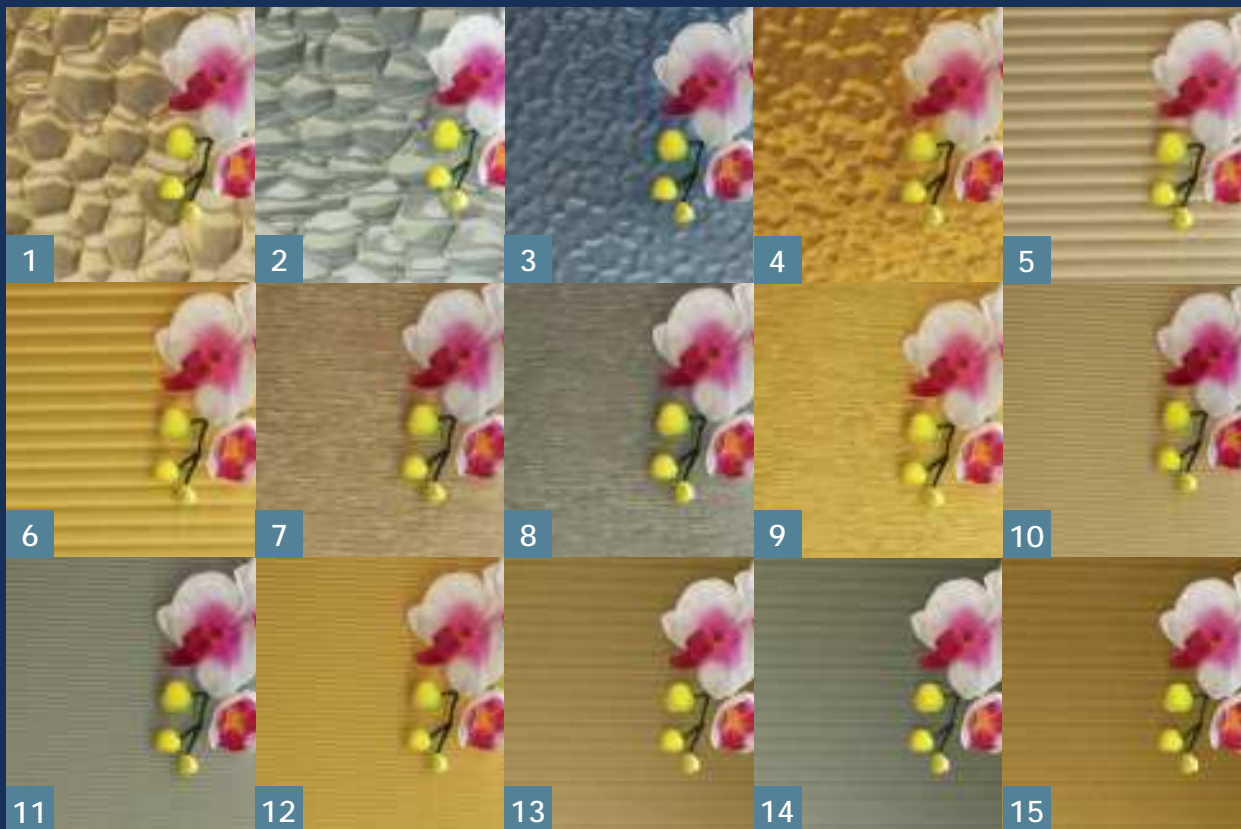

TYPE	THICKNESS	MAX SIZE
1. Amber Cube	5 mm	2400 x 1200 mm
2. Silver Cube	5 mm	2400 x 1200 mm
3. Blue Aqua	5 mm	2400 x 1200 mm
4. Golden Aqua	5 mm	2400 x 1200 mm
5. Amber Moru	5 mm	2400 x 1200 mm
6. Golden Moru	5 mm	2400 x 1200 mm
7. Amber Grain	5 mm	2134 x 1200 mm
8. Silver Grain	5 mm	2134 x 1200 mm
9. Golden Grain	5 mm	2134 x 1200 mm
10. Amber Twin	5 mm	2400 x 1200 mm
11. Silver Twin	5 mm	2400 x 1200 mm
12. Golden Twin	5 mm	2400 x 1200 mm
13. Amber Flute	5 mm	2400 x 1200 mm
14. Silver Flute	5 mm	2400 x 1200 mm
15. Golden Flute	5 mm	2400 x 1200 mm

CRYSTAL CLEAR GLASS

TYPE : THICKNESS - 5MM

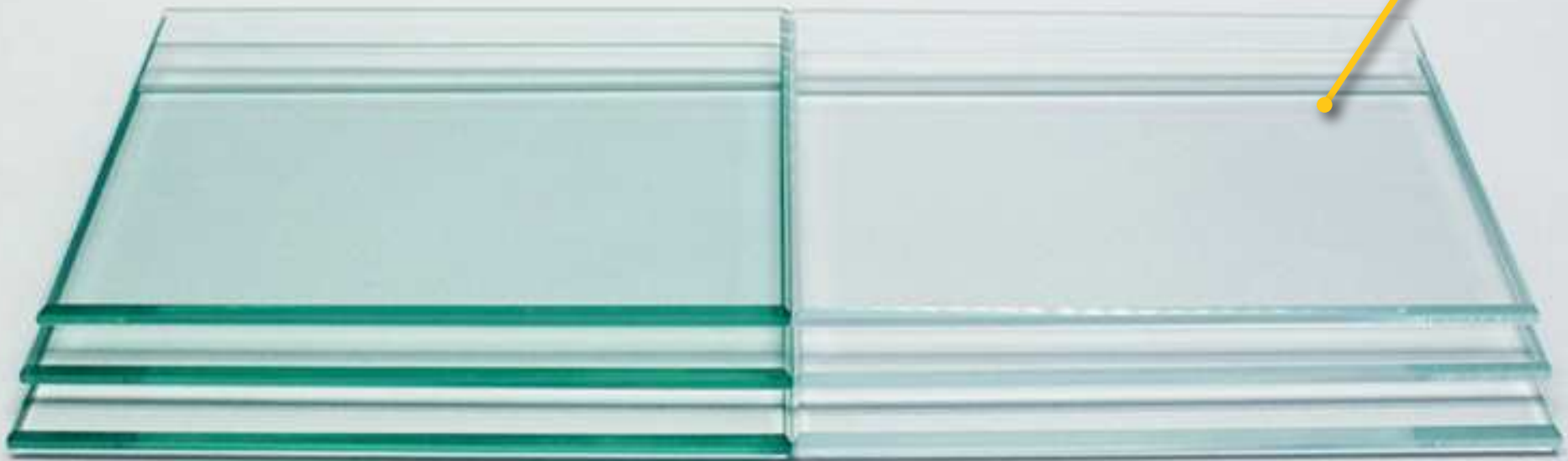

*Regular Float Glass

Glass Product

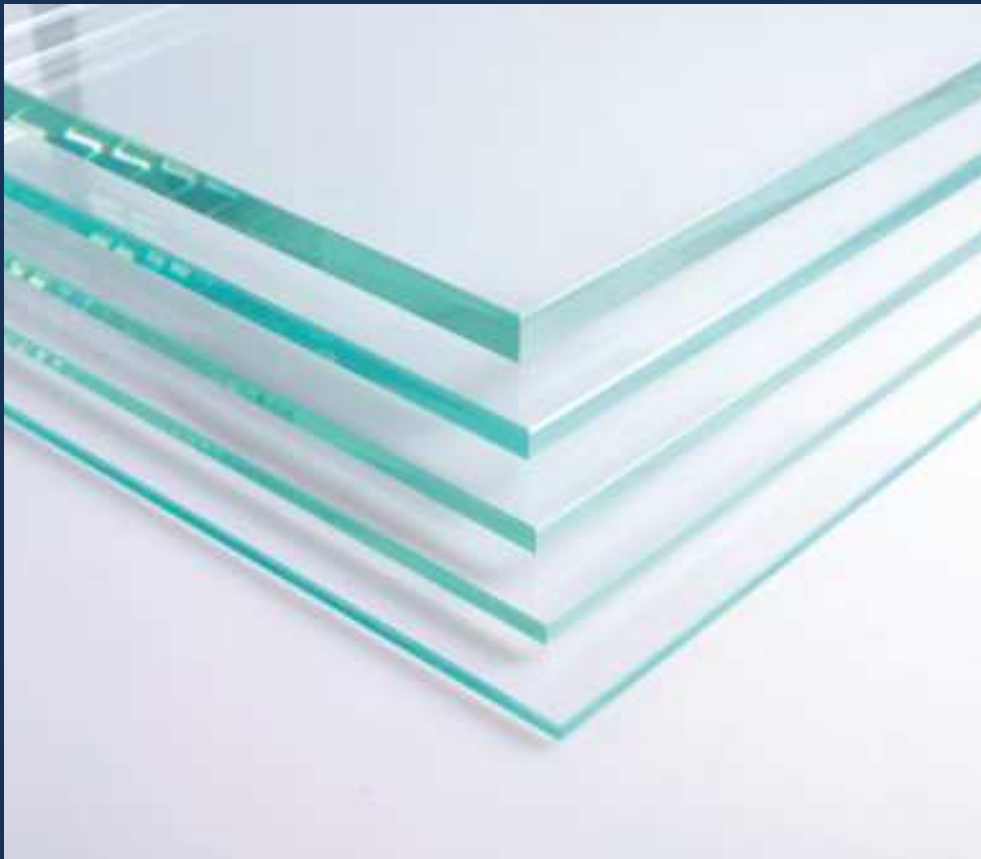

Crystal Clear Glass is a super clear glass product with a clean and elegant appearance and a very low level of color distortion and excellent visual transmission.

The level of clarity is like a crystal, obtained by reducing as much as possible the iron content during the production process so that the green or greenish effect commonly found in plain glass or ordinary clear glass generally disappears.

Crystal Clear Glass is the future of a normal float glass since it will give ultra clarity and minimum color distortion. When used as a raw material for further process (i.e: mirror or painted glass) will definitely enhance the sophistication level of the products.

CRYSTAL CLEAR GLASS SPECIFICATION

TYPE	THICKNESS	MAX SIZE
Crystal Clear Glass	5 mm	2140 x 3300 mm
Crystal Clear Glass	6 mm, 8 mm, 10,mm, 12 mm, 15 mm, 19 mm	2140 x 3660 mm



DANIA

TYPE : MORU - 10MM

Glass Product

Dania Patterned Glass is a glass material produced using a patterned roller on the sheet glass production machine to produce motives and textures on glass. Dania Patterned Glass has a distortion light transmission effect from the viewers sides. Dania Patterned Glass gives a vague effect when we look at an object. The most used variants from this series are the lines effect or commonly known as fluted glass series.

DANIA SPECIFICATION

TYPE	THICKNESS	DIRECTION	MAX SIZE
1. Moru	5 mm	Horizontal	1830 x 2440 mm
	10 mm	Horizontal	1830 x 3050 mm
2. Moru Frost	5 mm	Horizontal	1800 x 2410 mm
3. Twinlite	5 mm	Horizontal	2000 x 2440 mm
4. Twinlite Frost	5 mm	Horizontal	1830 x 2410 mm
5. Flutelite	5 mm	Horizontal	1830 x 2440 mm
6. Rain	5 mm	Horizontal	1830 x 2440 mm
7. Ripple	10 mm	Horizontal	1830 x 2440 mm
8. Grain	5 mm	Horizontal	1524 x 2134 mm
9. Prinstripe	5 mm	Horizontal	1830 x 2440 mm





DANIA

TYPE : AQUALITE - 5MM

Glass Product



Beside the lines or the fluted glass variants, Dania Patterned Glass also has many other interesting and extravagant textures. If one is looking for something different beside line patterns, one can consider these pattern variants. Since all patterns are created using the same patterned roller method on the sheet glass machine, one can be rest assured regarding the quality and consistency of this product. Therefore, one can find the pattern that is appropriate with the design style

DANIA SPECIFICATION

TYPE	THICKNESS	DIRECTION	MAX SIZE
1. Aqualite	5 mm	-	2000 x 2440 mm
2. Oceanic	5 mm	-	1830 x 2440 mm
3. Watercube	5 mm	-	1830 x 2440 mm
4. Crosspane	5 mm	-	2000 x 2440 mm
5. Nashiji	10 mm	-	1830 x 2440 mm
6. Spotlite	5 mm	-	1830 x 2440 mm



ACID ETCHED GLASS

TYPE : CLEAR ACID GLASS (G2) - 10MM

Glass Product

Acid Etched Glass is a glass or mirror material product offered by performing an acid-etching process on one side. Acid Etched Glass has smooth surface that is as soft as silk, and a blurry look that softens the incoming light completely and also gives the impression of privacy.

The acid etching process is a modern blurring technique in glass materials using an advanced chemical proses. With this technique, glass can be free from dirt stains or fingerprints, which we have often encountered on glass processed by sandblasting.

ACID ETCHED GLASS SPECIFICATION

TYPE	THICKNESS	MAX SIZE
1. Super Clear Acid Glass (G2)	5 mm	2080 x 3610 mm
2. Clear Acid Glass (G2)	5 mm	2080 x 3250 mm
	10 mm	2080 x 3610 mm
3. Grey Acid Glass (G2)	5 mm	2080 x 3610 mm
4. Bronze Acid Glass (G2)	5 mm	2080 x 3610 mm

ACID ETCHED MIRROR SPECIFICATION

TYPE	THICKNESS	MAX SIZE (W x H)
5. Grey Acid Mirror (G2)	5 mm	1780 x 3000 mm
6. Grey Acid Mirror (G2)	5 mm	1780 x 3000 mm
7. Bronze Acid Mirror (G2)	5 mm	1780 x 3000 mm



TEXTURA

TYPE : VALSA - 5MM



Glass Product

Textura is a product of glass which is equipped with frosted textures on the glass surface with deep etching techniques. Special techniques for making the textures look more clear and sturdy when compared to conventional glass etching methods.

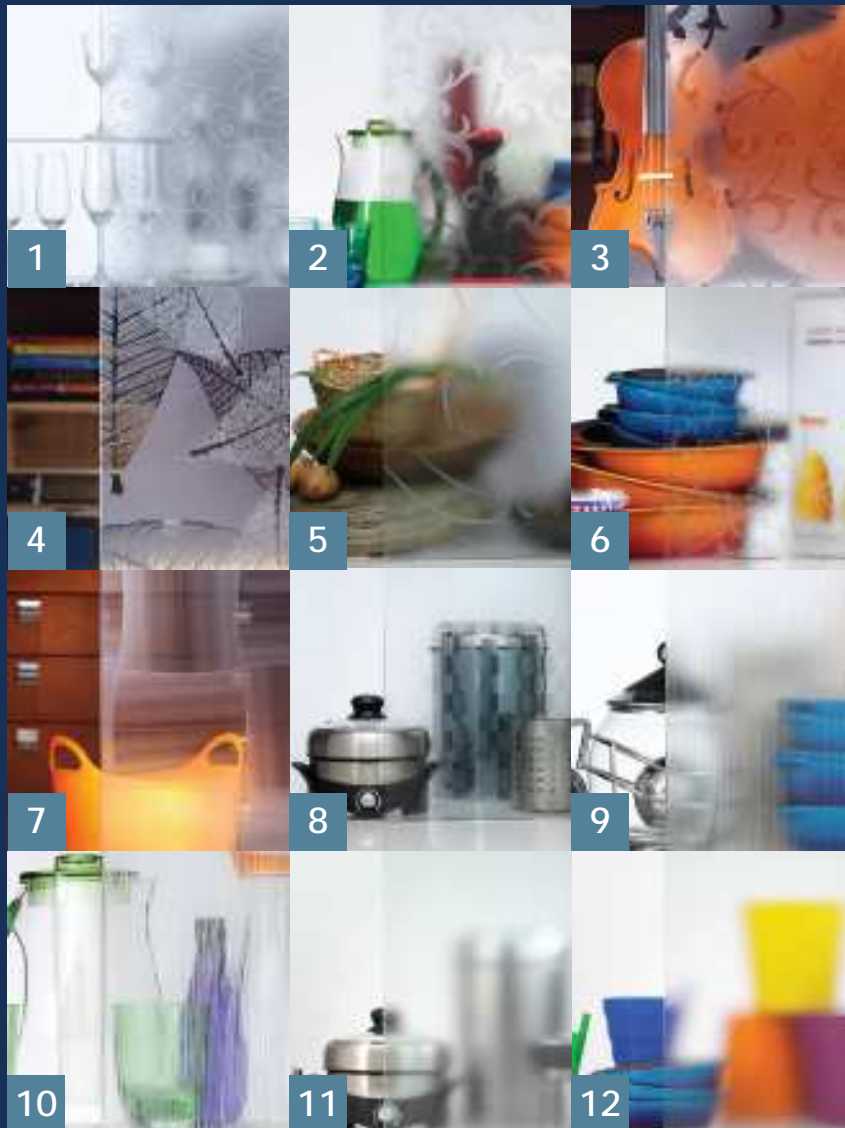

TEXTURA SPECIFICATION

TYPE	DIRECTION	THICKNESS	MAX SIZE
1. Valsa	-	5 mm	1800 x 2400 mm
2. Floria	-	5 mm	1800 x 2400 mm
3. Floria Clear	-	5 mm	1800 x 2400 mm
4. Tardoria	-	5 mm	1800 x 2400 mm
5. Manera	-	5 mm	1800 x 2400 mm
6. Gellera	-	5 mm	1800 x 2400 mm
7. Imperia	-	5 mm	1800 x 2400 mm
8. Barranda	Horizontal	5 mm	1800 x 2400 mm
9. Linea	Horizontal	5 mm	1800 x 2400 mm
10. Fillia	Horizontal	5 mm, 10 mm	1800 x 2400 mm
11. Guarda	-	10 mm	1800 x 2400 mm
12. Polka	-	10 mm	1800 x 2400 mm



LAMILUX

TYPE : CILIUM - 5MM+5MM (LAMINATED)

Film Product

Lamilux Glass and Film is a glass product with a laminated process from two glass materials with EVA interlayer material in the middle. Because of lamination process, we can get more various pattern and also can be customized as needed, by adding interlayer material such as patterned fabric or art paper on it, that is why this product is commonly known as fabric glass.

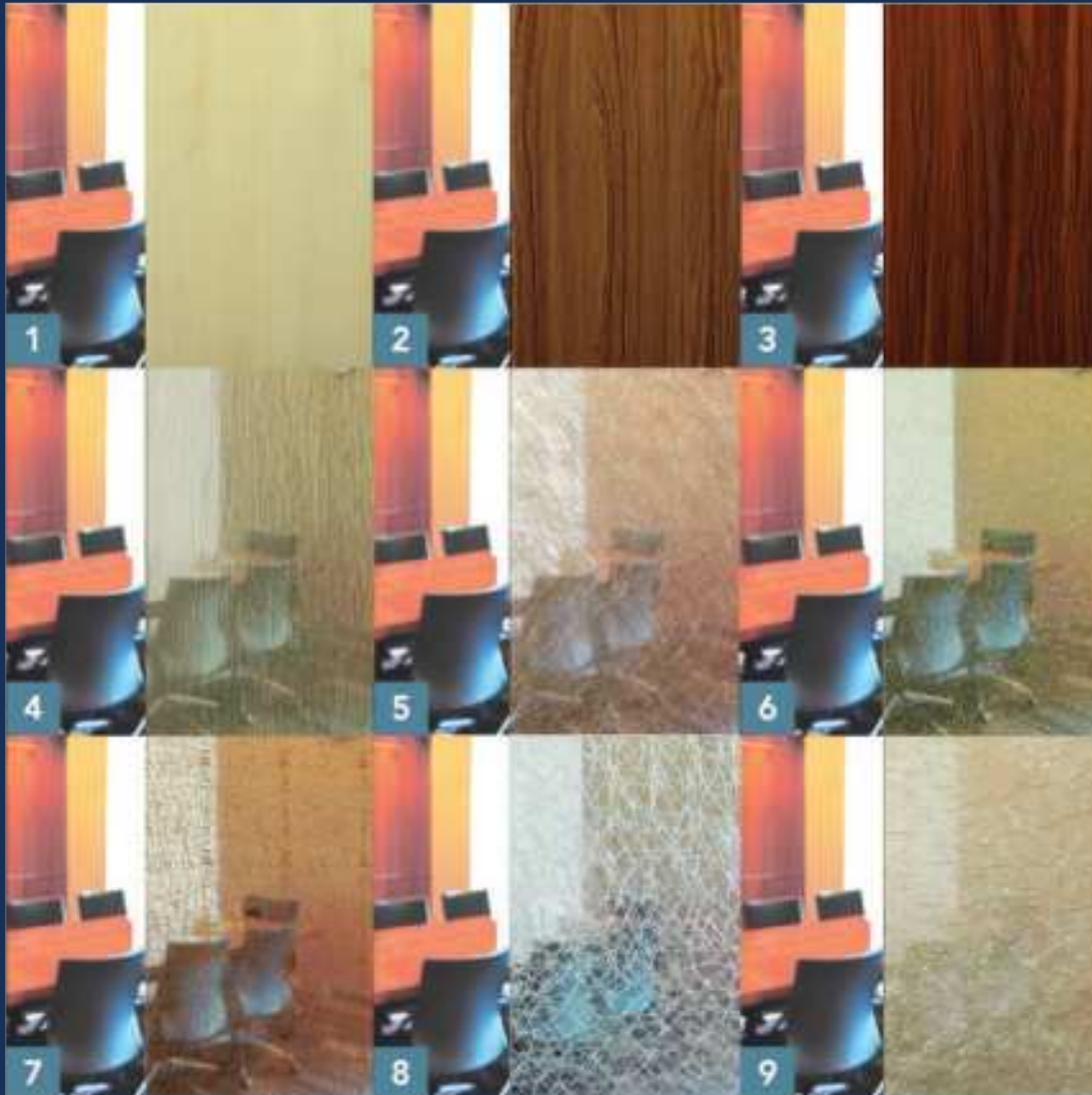

LAMILUX SPECIFICATION

TYPE	THICKNESS	MAX SIZE
1. Sungkai	5mm + 5 mm	1200 x 3000 mm
2. Rosewood	5mm + 5 mm	1200 x 3000 mm
3. Teakwood	5mm + 5 mm	1200 x 3000 mm
4. Array	5mm + 5 mm	1500 x 3000 mm
5. Vibrissa	5mm + 5 mm	1500 x 3000 mm
6. Golden Web	5mm + 5 mm	1500 x 3000 mm
7. String	5mm + 5 mm	1500 x 3000 mm
8. Cilium	5mm + 5 mm	1500 x 3000 mm
9. Gazette	5mm + 5 mm	1500 x 3000 mm

SWITCH GLASS

TYPE : PDLC SMART GLASS - 5MM+5MM (LAMINATED)

OFF MODE

ON MODE

Film Product

SWITCH GLASS

Switch Glass is unique combination between glass, PET-ITO film, and Polymer Dispersed Liquid Crystal integrated in a switchable interlayer unleashes the power to change the view from opaque to clear.

Structure and Operating Principle :

Polymer Dispersed Liquid Crystal layer exists between two pieces of transparent conductive film (PET-ITO film) in a phase separated structure of liquid crystal domain and polymer matrix. When the electrical power is off, the randomly oriented liquid crystal domains scatter light (opaque). However, when the electrical power is applied, the liquid crystal molecules in the domain orient along the direction of electric fields and it allows the light to pass through the film (transparent).

STRUCTURE

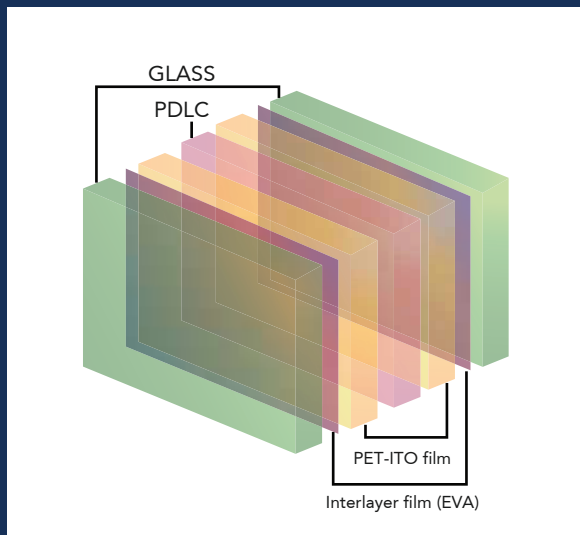

OPERATION PRINCIPLE

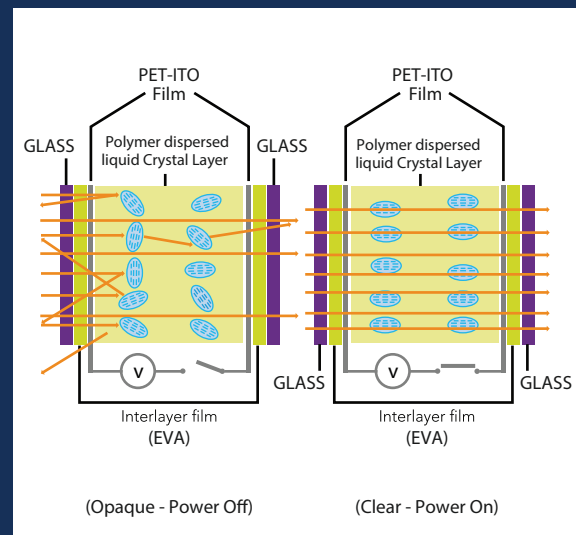

SWITCH GLASS SPECIFICATION

DESCRIPTION	MEASUREMENTS	
	ON / MAX	OFF / MIN
Operation Mode	Transparent / Clear	Opaque
Switching Speed	100 Ms	400 Ms
Light Transmission	80 +/- 1%	7.5 +/- 0.5%
Haze	2.9 +/- 0.5% (On Mode)	
Operating Temperature	-25 C to 85 C	
UV Block	>98%	
Projecting Viewing Angle	150	
Operating Voltage	AC 110 V, AC 65 V	
Frequency Range	50-60 Hz	
Power Consumption	+/- 4 W/m ²	
Standard Size	1000 x 2000 mm	
Custom Size	1500 x 3000 mm (max)	
Color Option	Opaque White	

Switch Glass is available in +/- 11mm (5mm Clear Glass + PDLC layer + 5mm Clear Glass) standard thickness laminated glass. Please check availability of glass thickness and sizes upon enquiry.

OFF MODE

ON MODE

SWITCH FILM

TYPE : PDLC SMART FILM



Film Product

SWITCH FILM

Attach the Switch Film directly on the existing glass. It will produce the same function as Switch Glass.

Structure and Operating Principle :

Polymer Dispersed Liquid Crystal layer exists between two pieces of transparent conductive film (PET-ITO film) in a phase separated structure of liquid crystal domain and polymer matrix. When the electrical power is off, the randomly oriented liquid crystal domains scatter light (opaque). However, when the electrical power is applied, the liquid crystal molecules in the domain orient along the direction of electric fields and it allows the light to pass through the film (transparent).

STRUCTURE

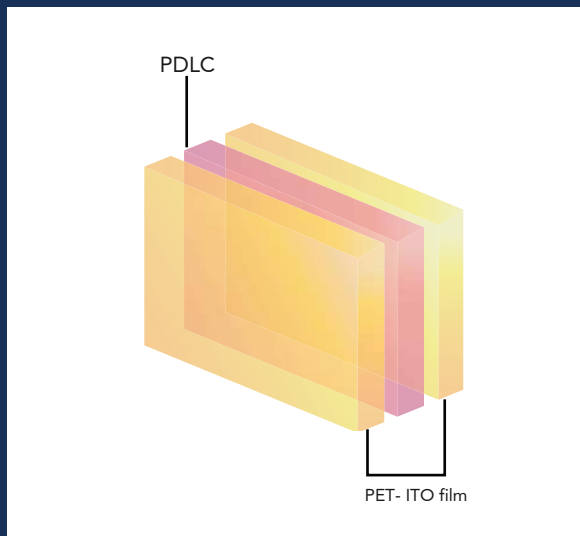

OPERATION PRINCIPLE

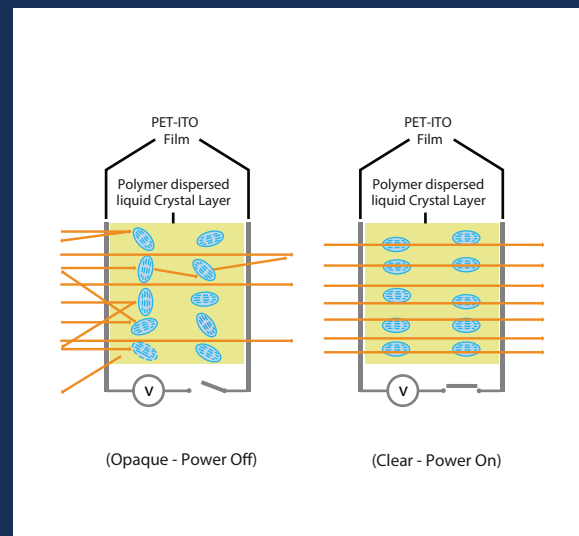

SWITCH FILM SPECIFICATION

DESCRIPTION	MEASUREMENTS	
	ON / MAX	OFF / MIN
Operation Mode	Transparent / Clear	Opaque
Switching Speed	100 Ms	400 Ms
Light Transmission	80 +/- 1%	7.5 +/- 0.5%
Haze	2.9 +/- 0.5% (On Mode)	
Operating Temperature	-25 C to 85 C	
UV Block	>98%	
Projecting Viewing Angle	150	
Operating Voltage	AC 110 V, AC 65 V	
Frequency Range	50 - 60 Hz	
Power Consumption	+/- 4 W/m ²	
Custom Size	1200 x 3200 mm (max)	
Color Option	Opaque White	

LIGHT ON

LIGHT OFF



MAXICOOL

TYPE : EURO BRONZE - 5MM

Glass Product



MaxiCool is a solar energy reflecting glass product, which is provided by providing a metal layer to the surface of colored glass. Able to absorb and reflect most of the heat energy from sunlight more effectively when compared to clear glass or colored glass products.

Therefore Maxicool often used as an exterior glass for its famous solar energy reduction. Especially for any applications that has a wide surface areas like curtain walls, canopies, or windows.

Furthermore, Maxicool also very applicable for interior purposes especially for furniture applications. The special coating on Maxicool can also be collaborated with interesting lighting manipulation inside any furniture so that it can create special effect. This application is very popular on wardrobes, kitchen cabinets, even also shoe racks.

MAXICOOL SPECIFICATION

TYPE	THICKNESS	MAX SIZE
1. Euro Bronze	5 mm	2140 x 3660 mm
2. Euro Grey	5 mm	2140 x 3660 mm
3. Ford Blue	5 mm, 8 mm	2134 x 3302 mm

MAXIFLOAT

TYPE : MAXICOOL EURO GREY - 5MM

Glass Product



MaxiFloat is categorized as tinted glass series. This product is made by float glass manufacturing process with adjustment on the raw materials to make various transparent colors. Not only aesthetically pleasing, MaxiFloat also could withstand and absorb heat into the glass so that the interior of a room will feel cooler.

This product is widely used also for interior purposes because of the transparent color that it possesses. By having transparent color, one can integrate the color use it as interior decoration for those who are keen to explore tinted colors on transparent glass. Therefore, one can use it not only for windows, but also for partitions, cabinets, and furniture.

MAXIFLOAT SPECIFICATION

TYPE	THICKNESS	MAX SIZE
1. Euro Bronze	5 mm	2134 x 3300 mm
2. Euro Grey	5 mm	2134 x 3660 mm



U-SHAPED GLASS

TYPE : OW (OPTIWHITE) - STANDARD PATTERN

Glass Product



U-SHAPES GLASS

TYPE	LENGTH	THICKNESS
CLEAR STANDARD PATTERN	6000	K25 /60 /7
	4600	K25 /60 /7
OW (OPTIWHITE) - STANDARD PATTERN	6000	K25 /60 /7
OW (OPTIWHITE) - SMOOTH	6000	K25 /60 /7

“U-Shaped Glass” from Himalaya Abadi is a machine rolled cast glass in u-shape, crafted specifically for architectural glass – both interior and exterior applications. Also known as profiled glass or channel glass, its unique shape allows to withstand imposed forces in conditions conventional flat glass incapable of.

U-Shaped Glass systems consist of the self-supporting profiled glass held in place by an extruded aluminum perimeter frame, creating seamless glass spans uninterrupted by metal structures, enabling a winding curve exposure as well as a neat glass-to-glass corners.

U-Shaped Glass is available in a variety of textures, translucencies and colors - allowing a soft and even light to filter through, while still maintaining an element of privacy.

These uniquely shaped glass products are available in multiple face widths, ranging 232-mm up to 331-mm, with a flange depth of 41-mm or 60-mm, in 6mm or 7mm glass thickness.

We provide Pilkington Profilit™ and also Appleton Uniprof™ channel glass systems with a variety of design options to meet project needs.

Disclaimer

- * All products are registered trademarks of Himalaya Abadi, except Pilkington **Profilit™**, Appleton Uniprof™ and Guardian UltraMirror™.
- * Product specifications may subject to change at any time without prior notice.
- * The color plates shown may vary slightly from the actual product colors due to the limitations of the printing process.
- * Please check for available glass color, textures/ patterns, thickness, and standard sheet size upon enquiry.

 @glassmart.id
www.glassmart.co.id

Visit Our Social Media :

 @himalayaabadi

 himalaya abadi

 himalaya abadi

 himalaya abadi

www.himalayaabadi.com